

CS530™

Wireless Headset System

User Guide

Contents

Welcome	3
What's in the Box	4
Base and Headset Basics	5
Accessories	6
Customize Your Headset	7
Change the Eartip	7
Position Your Headset	7
Connect Your Desk Phone	9
Connect the Power	9
Charge the Headset	9
Connect and Configure Your Desk Phone	10
Desk Phone (standard)	10
Check Configuration and Make a Test Call	11
Desk Phone plus HL10 Lifter (sold separately)	12
Desk Phone plus EHS Cable	14
Position Your Base	15
Your Headset	16
Headset Controls	16
Talk Time	16
Low Battery Warning	17
Muting Your Headset During a Call	17
Adjusting Your Headset Volume	17
Out of Range Warning Tones	17
Your Base	18
Base Phone Button and Switches	18
Subscription Button	18
Wideband/Narrowband Audio Switch	19
Auto Answer Switch	19
Daily Use	20
Place an Outgoing Call	20
Answer an Incoming Call	20
Conference Up to Three Additional Headsets	20
Troubleshooting	21
Headset	21
Desk Phone	21

Welcome

Congratulations on purchasing your new Plantronics product. This guide contains instructions for setting up and using your CS530 Wireless Headset System.

Please refer to the separate [safety instructions](#) for important product safety information prior to installation or use of the product.

The enclosed DECT 6.0 wireless product uses restricted wireless radio frequencies which vary by country. DECT 6.0 devices are generally authorized for use in The Americas. Use of this DECT 6.0 product in unauthorized countries is a violation of law, may disrupt telecommunications networks and devices, and can subject you to fines and penalties by regulatory agencies. For specific countries in which DECT 6.0 devices may be lawfully used, please consult the following:

<http://www.dect.org/content.aspx?id=28>

What's in the Box

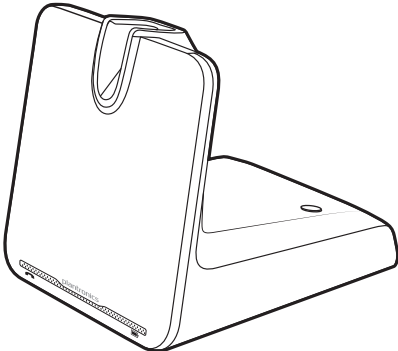

Base

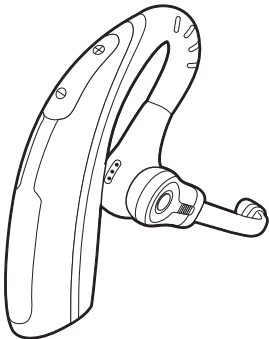

Headset

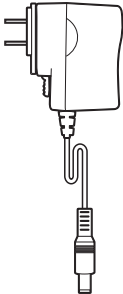

Power supply



Eartips

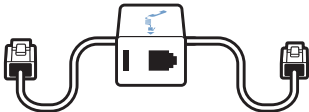

Telephone interface cable

Base and Headset Basics

Base overview

FRONT

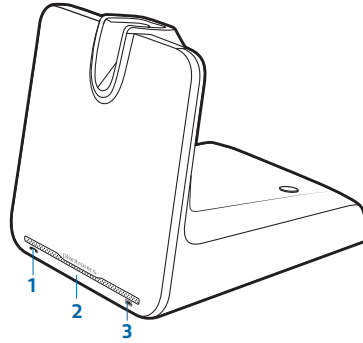

BACK

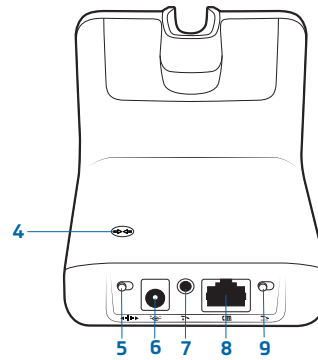

BOTTOM

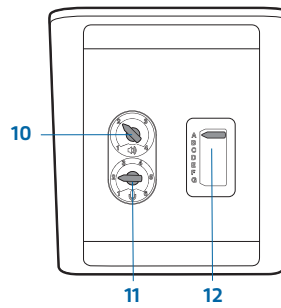

- 1 Call/mute LED
 - 2 Power on/subscription LED
 - 3 Charging LED
 - 4 Subscription button
 - 5 Narrowband/wideband audio switch
 - 6 Power jack
 - 7 Handset lifter/EHS cable jack
 - 8 Telephone interface cable jack
 - 9 Auto answer switch
 - 10 Listening volume dial*
 - 11 Speaking volume dial*
 - 12 Configuration switch*
- * For installation set up

Headset overview

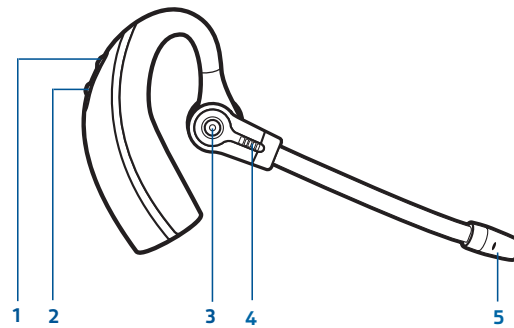

- 1 Volume up button
- 2 Volume down button
- 3 Call control button
- 4 Indicator light
- 5 Microphone

Accessories

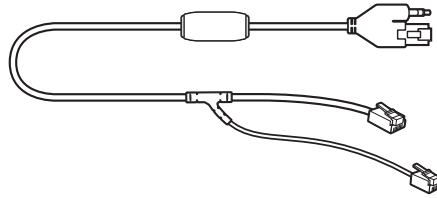

1

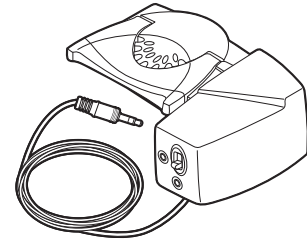

2

- 1 Electronic Hookswitch Cable (EHS)** Electronically takes your desk phone handset off hook. Enables remote call answer/end with your headset.
- 2 HL10™ Lifter** Automatically lifts handset and returns it to the cradle. Enables remote call answer/end with your headset

Customize Your Headset

Customize the headset by changing the eartip, wearing it on the right or left and optimizing the position of the microphone.

Change the Eartip

- 1 The headset comes with a pre-installed eartip. To install a different eartip see the following: Remove the pre-installed eartip by pushing in and turning the eartip **CLOCK**wise, then pull firmly.

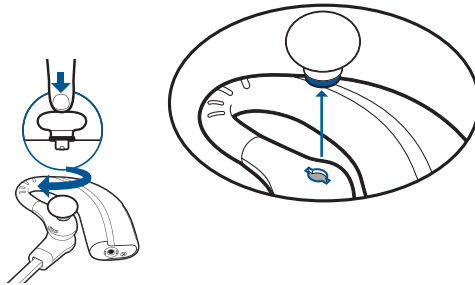

- 2 Choose the size and style of eartip that fits most comfortably. Align eartip tabs with notches in headset. Push in firmly and twist **COUNTER** clockwise.

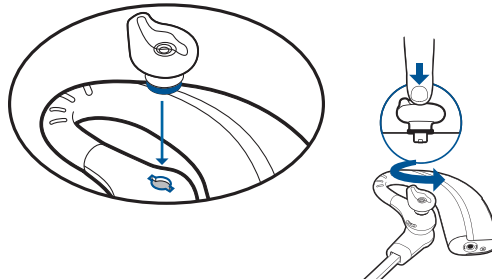

NOTE When installing a gel tip ensure the raised part of the eartip is pointed toward the curved section of the headset as shown.

Position Your Headset

When you wear the headset, the microphone should rest as close to your cheek as possible without touching. The microphone can be adjusted inward by pivoting the earpiece to optimize the position of the headset.

- 1 Slide the headset over and behind your ear, then press gently toward your ear.

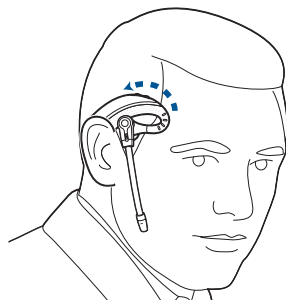

- 2 Rotate the microphone boom until it is pointed toward your mouth.

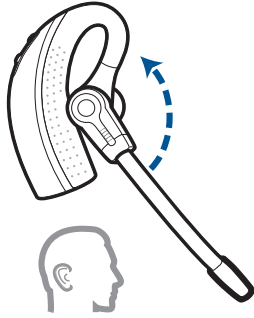

Left Ear Wearing

- 1 The headset can be converted for wearing on left ear as follows:

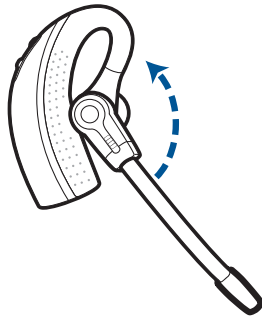

- 2 Turn microphone boom around.

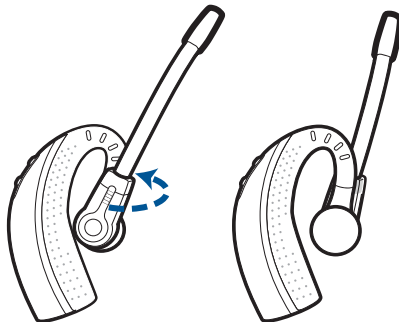

- 3 Rotate microphone boom down.

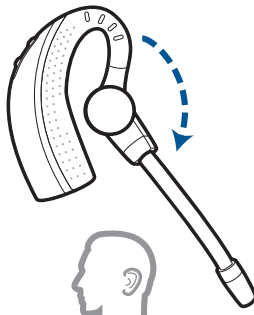

Connect Your Desk Phone

This section describes how to connect the base to your desk phone.

Connect the Power

Plug one end of the power supply into the power jack on the back of the base and the other end into a working power outlet. The Power On LED will be solid white.

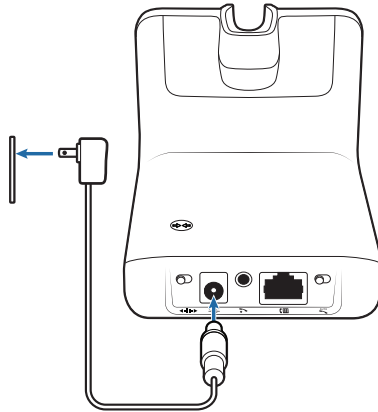

Charge the Headset

Place the headset in the charge cradle. The charging LED on the base will flash green when charging and turn solid green when the headset is fully charged. Charge for at least 20 minutes prior to the first use. A full charge takes 3 hours.

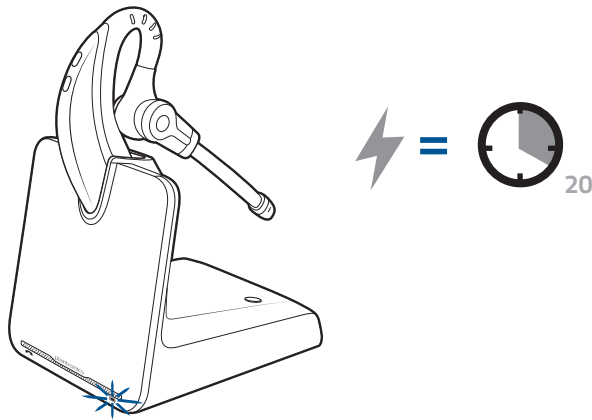

Connect and Configure Your Desk Phone

There are three setup options for connecting the CS530 to your desk phone. Select one of the following and continue.

- Desk phone (standard)
- Desk phone + HL10 lifter (sold separately)
- Desk phone + EHS cable (sold separately)

NOTE If you will be using a standard desk phone set up or a desk phone with an HL10 lifter, continue below. If you will be using the desk phone with an EHS cable, refer to [Desk phone plus EHS cable](#) section in this guide. For further installation information refer to the [EHS Getting Started guide](#) that came with your EHS cable or at plantronics.com/accessories.

Desk Phone (standard)

- 1 Connect one end of the telephone interface cable to the back of the base.
- 2 Disconnect the handset coil cord from the desk phone and re-connect it to the telephone interface cable junction box.
- 3 Connect the remaining end of the telephone interface cable into the open handset port on the desk phone.

NOTE Your desk phone handset will continue to work; it's just hooked up differently.

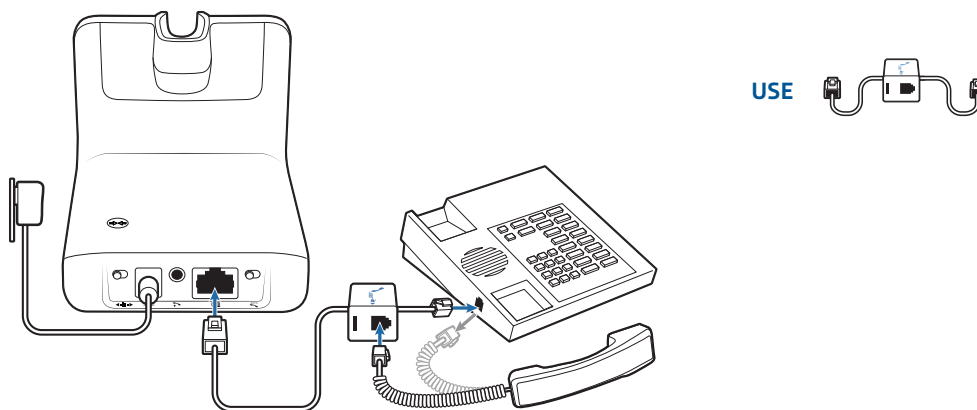

NOTE If your phone has a built-in headset port, you should only use the headset port if you will not be using the HL10 lifter. In this configuration, you must press both the headset button on your phone and the call control button on the headset to answer or end calls.

Check Configuration and Make a Test Call

- 1 If your desk phone has a volume control set it to mid-range.
- 2 Look at the bottom panel of your base and make sure the default settings are correct. Set your desk phone's volume also.

listening volume dial (🔊) = 2 and speaking volume dial (🎤) = 2

configuration switch = A

desk phone volume = mid-range

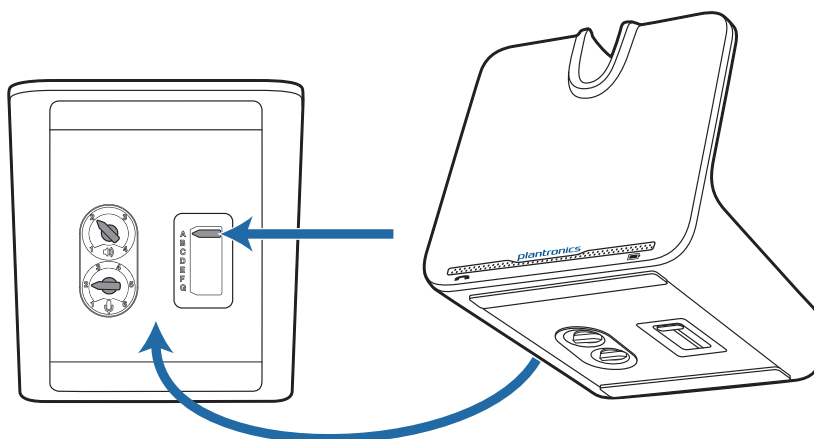

- 3 Remove the handset from desk phone cradle.
- 4 While wearing your headset, press the call control button on the headset.
- 5 If you do not hear a dial tone, adjust the configuration switch (A-G) until you do.

NOTE For most phones, these factory default settings will sound the best.

- 6 Dial a test call from the desk phone. If needed, fine tune the volume with the headset volume controls. You can also adjust the desk phone speaking and listening volumes on the bottom of the base.

Desk Phone plus HL10 Lifter (sold separately)

NOTE First follow the steps above for Desk Phone (Standard).

- 1 Firmly press the handset lifter power cord into the handset lifter jack.

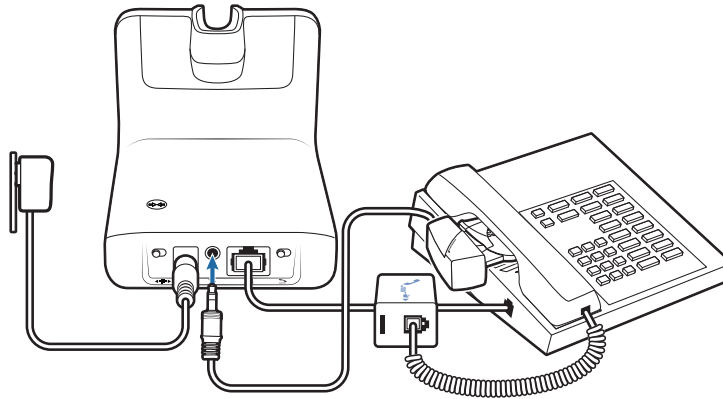

- 2 While wearing your headset, slide the handset lifter arm under the handset until the lifter base touches the side of the phone.

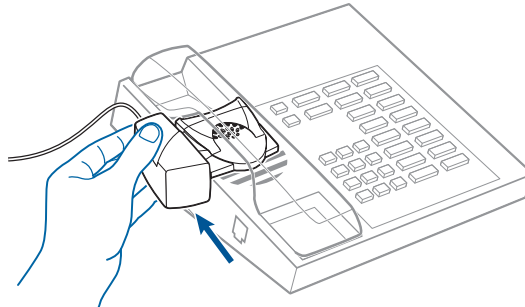

- 3 Slide the lifter up to where it nearly touches the handset earpiece.
- 4 Press the call control button on your headset to activate the lifter.
- 5 If you hear a dial tone the lifter is set correctly and needs no adjustment.
- 6 Remove the protective strips from the 3 mounting tapes on the underside of the lifter.
- 7 Gently place the lifter on the desk phone in the pre-determined position.
- 8 Press firmly to adhere.

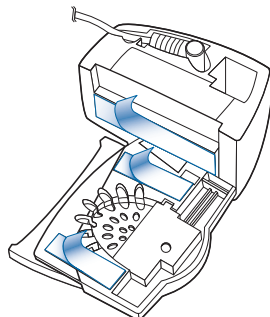

If You Do Not Hear a Dial Tone

- 1 If you do not hear a dial tone, raise the lifter height switch to the next highest position.

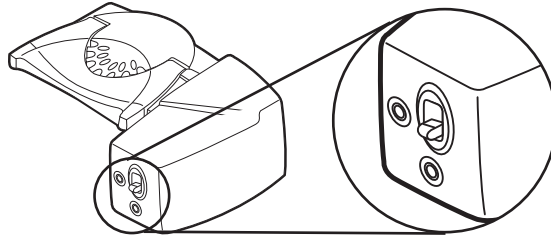

- 2 Repeat steps 2 through 5 above as necessary until you hear a dial tone.
- 3 When you hear a dial tone, secure the lifter as described in steps 6 through 8.

Additional Parts (if required)

Use extender arm when the handset lifter needs additional stability lifting and returning handset to cradle.

Extender Arm

- 1 Slide extender arm onto lifter.
- 2 Stabilizers can be shifted left and right. Position stabilizers on outsides of handset to gently grip the phone.

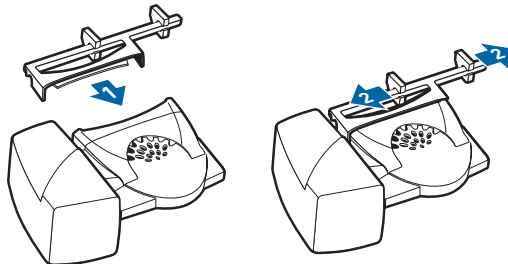

Ringer Microphone

Use ringer microphone only when the telephone speaker is not located directly under the handset.

- 1 Remove cover from ringer microphone jack on back of lifter.
- 2 Connect ringer microphone plug.
- 3 Place ringer microphone over phone speaker. Remove adhesive tape and attach.

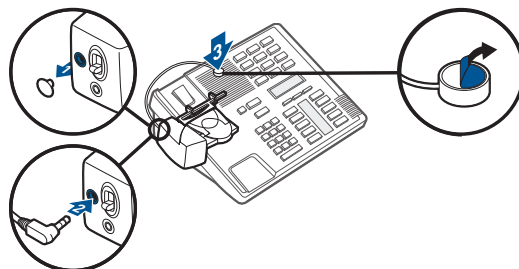

For Nortel Phones Only

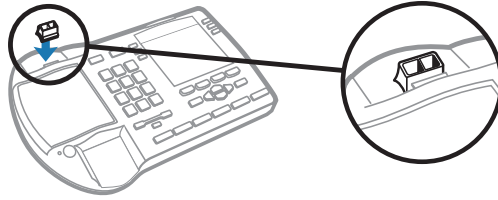

Desk Phone plus EHS Cable

- 1 Connect the end of the EHS cable to the base and the other end to the desk phone as described in the EHS Adapter Getting Started guide.

NOTE For further installation information refer to the [EHS Getting Started guide](#) that came with your EHS cable or at plantronics.com/accessories.

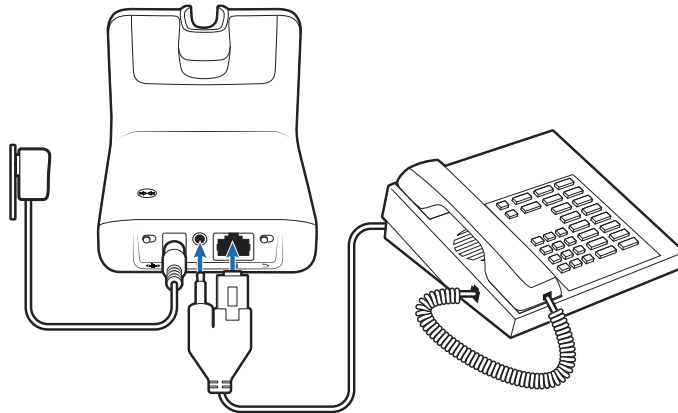

Position Your Base

The minimum recommended separation between your desk phone and the base is 6 inches.

The minimum recommended separation between the base and computer is 12 inches. Incorrect position can cause noise and interference problems.

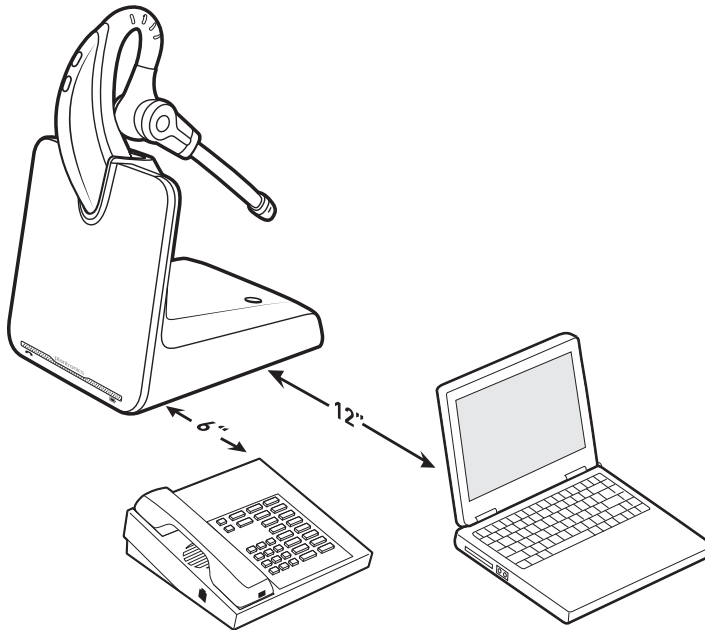

Your Headset

Now that you've adjusted your headset and connected your desk phone, read this section to learn about the headset features, how to use the controls and more.

Headset Controls

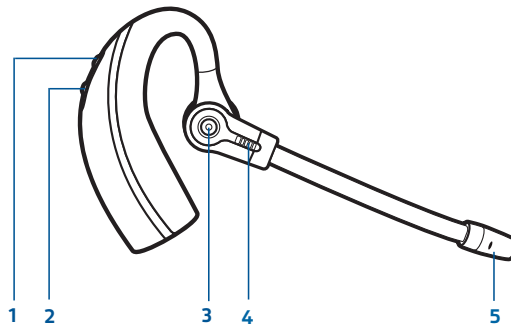

1 Volume up

Increase the volume

Press the volume button up +

2 Volume down/Mute button

Decrease the volume

Press the volume button down –

Mute/unmute a call

To mute/unmute the headset, press the volume button down – for 1.5 seconds

3 Call control button

Place, answer, end a call

Press the call control button

4 Headset LED

Flashes white when in use

5 Microphone



IMPORTANT For your safety, do not use headset at high volumes for extended periods of time. Doing so can cause hearing loss. Always listen at moderate levels. For more information on headsets and hearing visit: [plantronics.com/healthandsafety](https://www.plantronics.com/healthandsafety).

Talk Time

With a single full charge, the CS530 will provide up to 6 hours of talk time. Talk time will be reduced when operating in wideband mode or if the headset is used consistently at a far distance from the base.

Low Battery Warning

If you are on a call and the headset battery is critically low, you will hear a repeated single low tone every 15 seconds indicating that the battery is low. You should recharge the headset immediately.

If you are not on a call and press the call control button, you will hear three low tones if the battery is critically low. You should recharge the headset immediately.

Muting Your Headset During a Call

To mute/unmute the call, press the volume button down – for 1.5 seconds.

When mute is activated, the Call/mute LED on the base will be solid red and you will hear three high tones (you will still be able to hear the caller).

Adjusting Your Headset Volume

Fine-tune your headset volume by pressing the volume [+] button to increase or the volume [-] button to decrease.

Make set up volume adjustments for the desk phone with the base volume dials.

Out of Range Warning Tones

If you are on a call and go out of the operating range, you will hear three low tones. You will hear a single mid tone when you are back in range.

If you stay out of range, an active call will be suspended. The call will be re-established when you walk back into range. If you remain out of range for more than 5 minutes, the system will drop the call.

If you are not on a call and go out of the operating range and then press the call control button, you will hear a single tone for the button press and three low tones for the failure to make a link.

Your Base

Base Phone Button and Switches

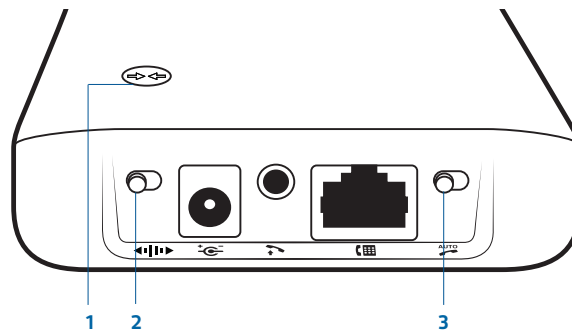

1 Subscription Button

The headset and base that came in the box are subscribed (connected) to each other. However, if you wish to use a new headset or need to restore subscription to your current headset, the units can be subscribed to each other by the following two methods.

Automatic Secure Subscription

With your system idle, docking a headset will automatically subscribe it to the base, making it the primary headset. The Power On/Subscription LED will flash white during subscription process and become solid white when the new subscription is established.

Manual Over-the-Air Subscription

- 1 With your system idle and your headset undocked, press and hold the subscription button on the base for three seconds. The Power on/subscription light will flash white.
- 2 Press and hold the volume up button on the headset for three seconds until the headset LED turns solid white. When the Power on/subscription LED on the base becomes solid white, the headset and base are subscribed to one another.

NOTE If the subscription process times out after two minutes or if the subscription process fails, the subscription LED on the base will go dark for three seconds and then re-illuminate steadily to indicate power is applied to the base. If this occurs, try to re-subscribe the headset again.

Ending Subscription

If the base is in subscription mode and you want to stop the base from searching for a headset, press the subscription button again. The subscription LED on the base will go dark for three seconds and then re-illuminate steadily to indicate power is applied to the base.

Power On/Subscription LED

Base Status

Power On/Subscription LED

Primary headset subscription	Flashes white
Primary headset subscribed to base	Solid white
Conference call headset subscription	Flashes white
Active conference call with guest headsets	Flashes white

2 Wideband/Narrowband Audio Switch

The CS530 has wideband audio, which allows speech to sound clearer and more natural. If your desk phone is capable of wideband audio, set the Wideband-Narrowband audio switch to yellow for wideband.

NOTE: Talk time will be reduced when operating in wideband mode.

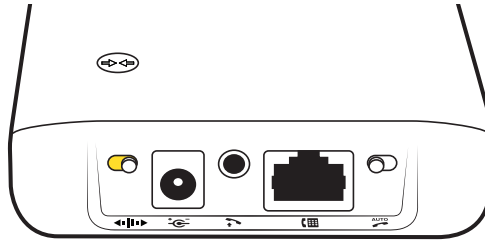

Set the switch to black (narrowband) for longer headset battery life or to increase the number of systems that can work in a small area.

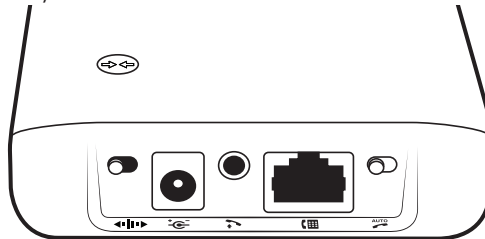

3 Auto Answer Switch

Auto answer saves a button press to establish the radio link between headset and base. When auto answer is set to black you must press the headset call control button to answer an incoming call.

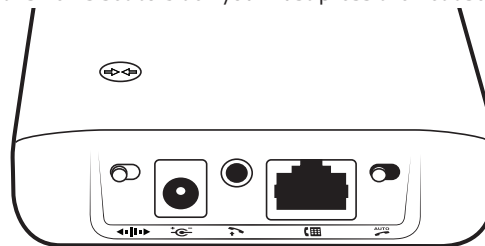

When Auto Answer is set to gray you can answer a call just by lifting headset from the base.

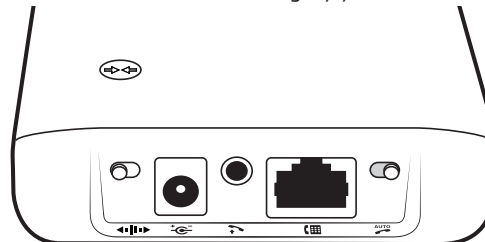

NOTE Auto answer/end capability requires the use of an EHS cable or HL10 lifter. Visit plantronics.com/accessories for more information.

Daily Use

Place an Outgoing Call

- 1 Wearing your headset, press the headset call control button.
- 2 Remove the handset from the cradle. You will hear a dial tone.

NOTE This step will be automatic if you install a lifter or EHS cable accessory. For a complete list of accessories, visit plantronics.com/accessories.

- 3 Dial the number using your desk phone.
- 4 To end the call, press the headset call control button and hang up the handset.

Answer an Incoming Call

- 1 Wearing your headset, press the headset call control button.
- 2 Remove the handset from the cradle speak to your caller.

NOTE This step will be automatic if you install a lifter or EHS cable accessory. For a complete list of accessories, visit plantronics.com/accessories.

- 3 To end the call, press the headset call control button and hang up the handset.

Conference Up to Three Additional Headsets

You can conference up to three additional headsets to a call in progress.

Join a Conference Call

While in an active link between the primary headset and the base (on a call), place the guest headset into the primary user's charge cradle (this connects the headset to the base). The base subscription LED will begin flashing. After a few moments, the primary user will hear a triple tone in their headset indicating the guest headset wishes to join the call. Within ten seconds of hearing the triple tone, press the primary headset's call button to accept the guest headset. If the process fails or times out because the button was not pressed within ten seconds the guest subscription is terminated and the guest will hear an error tone in their headset.

To connect a guest headset that is of different variety than the primary headset press the base subscription button while the base has an active link. Next, press the guest headset volume up button until the indicator light turns on. The base subscription LED will begin flashing and the primary user will hear a triple tone in their headset indicating the guest headset wishes to join the call. Within ten seconds of hearing the triple tone, press the primary headset's call button to accept the guest headset. If the process fails or times out because the button was not pressed within ten seconds the guest subscription is terminated and the guest will hear an error tone in their headset.

NOTE Headsets in a conference maintain independent mute controls. The base only indicates the primary user's mute state.

Exit a Conference Call

Guests headsets can remain as guests through multiple calls. To remove a guest headset, press the guest headset's call control button or dock the primary user's headset in the charge cradle. A single tone in the master headset will be heard as each guest leaves the call.

NOTE The user of the primary headset in a multiple headset conference scenario may hear additional tones (triple tones) in their headset and see the subscription LED on the base flash as guest headsets join the call. These additional tones and flashing LED indicate that the guest headset has a different version of firmware than the primary headset, but can still be used for conferencing.

Troubleshooting

HEADSET

Headset has to be charged too often. Switch the Wideband-Narrowband audio switch to narrowband (black).

Talk time is not as long as stated.

Talk time performance is significantly degraded even after a full recharge. Battery is wearing out. Call Plantronics at (800) 544-4660 for factory replacement information or contact us at plantronics.com/support.

Desk Phone

I can't hear a dial tone in the headset. Make sure your headset is charged.
Make sure your headset is subscribed to base. See [Subscription button](#).
Press the call control button on your headset.
If using a lifter, make sure the lifter is lifting the handset high enough to operate the hookswitch; set to a higher setting if necessary.
Adjust the configuration switch on the base until a dial tone is heard.
Fine tune the listening volume on the headset.
If the volume is still too low, adjust the Listening volume dial on the base.

I hear static. Make sure there is at least 12 inches between your base and your computer, and 6 inches between your base and your telephone. You may hear static as your headset is going out of range; move closer to the base.

The sound is distorted. Lower the Speaking volume dial or Listening volume dial on the base. For most telephones the correct setting is position 2.
If your desk phone has a volume control, lower until the distortion disappears.
If the distortion is still present, adjust the headset volume control to lower the headset speaker volume. If the distortion persists, lower the Listening volume dial on the base.
Make sure there is at least 12 inches between your base and your computer, and at least 6 inches between your base and your telephone.

I hear echo in the headset. Lower the Listening volume dial and Speaking volume dial on the base. For most telephones, the correct setting is position 2.
If the audio level is too low in this position, adjust the headset volume control to increase the headset speaker volume.
If your speaking volume is too low for your listener in this position, adjust the position of the headset to make sure the microphone is a finger's width from the corner of your mouth.
Adjust the Configuration switch. The most commonly used position is "A".

People I talk to can hear a buzz in the background. Move the base further away from your phone.
If the base power supply is plugged into a power strip, plug it into the wall directly.

The handset lifter is installed but does not lift the handset. Be sure the handset lifter power cord is firmly pushed into the handset lifter jack on the base.

NEED MORE HELP?

plantronics.com/support

Plantronics, Inc.
345 Encinal Street
Santa Cruz, CA 95060
United States

© 2013 Plantronics, Inc. All rights reserved. Plantronics, the logo design, CS530, and HL10 are trademarks or registered trademarks of Plantronics, Inc. All other trademarks are the property of their respective owners.

Patents US 6735453; 7633963; D603,372; BR D169024340; China ZL 200930195205.X; EM 001151336-0002; IN 223634; Taiwan D135154
200977-06 (0713)



plantronics®